

CARACTÉRISTIQUES

- Montée sur deux roues fixes, facile à déplacer.
- Grilles facilement interchangeables.
- Aucun raccordement électrique nécessaire.
- Bac de fleurage magnétique.
- Encombrement réduit.
- Rangement pour 4 grilles.
- Fournie avec un bac de division et deux grilles.
- Découpe et mise en forme manuelle.

FEATURES

- Mounted on two fixed wheels, easy to move.
- Cutting grids easily interchangeable.
- No electrical connection required.
- Magnetic flour box.
- Takes little space.
- Storage for 4 grids.
- Equipped with dividing bin and 2 cutting grids.
- Manual dough dividing and moulding.









EIGENSCHAPPEN

- Gemonteerd op twee vaste wieltjes, gemakkelijk te verplaatsen.
- De roosters zijn gemakkelijk te verwisselen.
- Geen elektrische aansluiting nodig.
- Magnetisch bloembakje.
- Neemt weinig plaats in.
- Opbergruimte voor 4 roosters.
- Standaard met een verdeelbak en twee roosters.
- Manuele deegverdeling en -vorming.



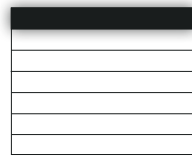

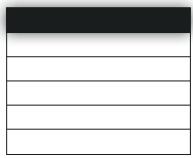







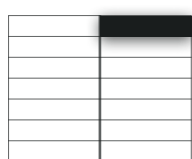

GRILLES EN PLASTIQUE | PLASTIC GRIDS | PLASTIC ROOSTERS

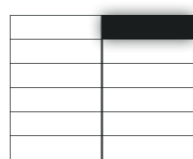
Simple division | Single division | Enkele verdeling

 	 	 	 
MSG101001P	MSG080801P	MSG070107P	MSG060106P
10 (10 x 1)	8 (8 x 1)	7 (1 x 7)	6 (1 x 6)
180 - 500 gr	225 - 625 gr	255 - 710 gr	300 - 830 gr
30 x 334 mm	41 x 334 mm	454 x 47 mm	454 x 54 mm

Double division | Double division | Dubbele verdeling



 	 	 	 	 	 
MSG201002P	MSG160802P	MSG140207P	MSG120206P	MSG100502P	MSG080402P
20 (10 x 2)	16 (8 x 2)	14 (2 x 7)	12 (2 x 6)	10 (5 x 2)	8 (4 x 2)
90 - 250 gr	110 - 310 gr	125 - 355 gr	150 - 415 gr	180 - 500 gr	225 - 625 gr
30 x 160 mm	41 x 160 mm	224 x 45 mm	224 x 54 mm	155 x 80 mm	155 x 105 mm

Grilles à couteaux profilés:
couteau en polyoxymethylene
alimentaire profilé pour une soudure
parfaite de la pâte lors de la division.

Grids with angled blades:
food-proof polyoxymethylene angled
blade for a perfect welding of the
dough upon being divided.

Roosters met profielmes:
voedingsgeschikt polyoxymethyleen
profielmes voor een perfecte lassing
van het deeg bij het verdelen.

GRILLES INOX | STAINLESS-STEEL GRIDS | RVS ROOSTERS





MSG060601

6 (6 x 1)

300 - 1000 gr

73 x 334 mm





MSG080801

8 (8 x 1)

225 - 750 gr

54 x 334mm





MSG101001

10 (10 x 1)

180 - 600 gr

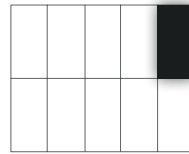
42 x 334 mm





MSG100502

10 (5 x 2)

180 - 600 gr

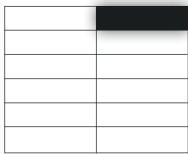
88 x 160 mm





MSG120206

12 (2 x 6)

150 - 500 gr

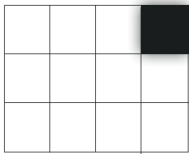
224 x 53 mm





MSG120403

12 (4 x 3)

150 - 500 gr

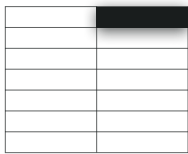
115 x 108 mm





MSG140207

14 (2 x 7)

125 - 425 gr

224 x 47 mm





MSG200504

20 (5 x 4)

90 - 295 gr

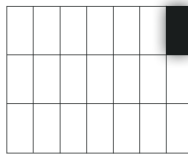
87 x 80 mm





MSG210703

21 (7 x 3)

85 - 285 gr

62 x 108 mm





MSG240803

24 (8 x 3)

75 - 250 gr

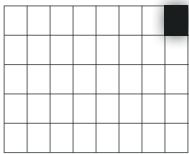
57 x 108 mm





MSG400805

40 (8 x 5)

45 - 125 gr

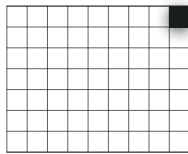
54 x 64 mm





MSG630907

63 (9 x 7)

25 - 63 gr

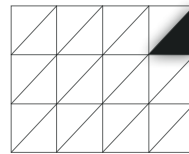
47 x 45 mm

MSG240403/2

24 (4 x 3) x 2

75 - 165 gr

115 x 108 x 150 mm

Poids et dimensions peuvent varier selon le type de pâte. ■ Weight and dimensions may vary depending on the type of dough. ■ Gewicht en afmetingen kunnen variëren, afhankelijk van het soort deeg.



Grilles facilement interchangeables.
Cutting grids easily interchangeable.
De roosters zijn gemakkelijk te verwisselen.

Bac de fleurage magnétique.
Magnetic flour bin.
Magnetisch meelbakje.

Support retractable pour le bac de division.
Extractable support for the division bin.
Uitschuifbare geleider voor de verdeelbak.

Plaque de tassage aussi disponible.
Pressing plate also available.
Drukplaat ook beschikbaar.

Rangement pour 4 grilles.
Storage for 4 grids.
Opbergrek voor 4 roosters.

Option: Echelle
Option: Trolley
Optie: Rek

Bacs Bins Bakken	14
Couvercles Lids Deksel	14
Capacité Capacity Capaciteit	9,8 L (5 - 6 kg)



VUE LATÉRALE | SIDE VIEW | ZIJAANZICHT

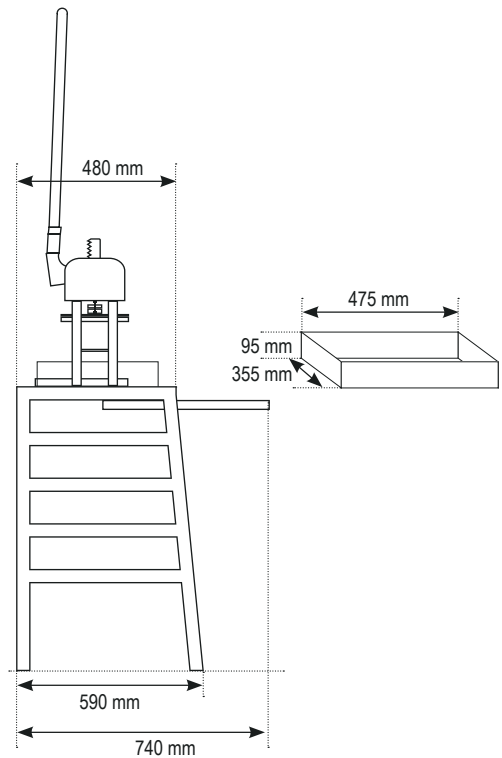

VUE DE FACE | FRONT VIEW | VOORAANZICHT

